

ITD69H00 - Rectangular signal

 Through hollow shaft $\varnothing 40$ to $\varnothing 65$ mm

128...4096 pulses per revolution

Overview

- Bearingless magnetic encoder
- Max. 4096 pulses per revolution
- Output circuits: HTL or TTL
- Fast, easy and space saving installation
- Maintenance-free
- High accuracy - error max. $\pm 0.2^\circ$
- Rotation speed max. 10000 rpm
- High resistance to dirt and vibrations

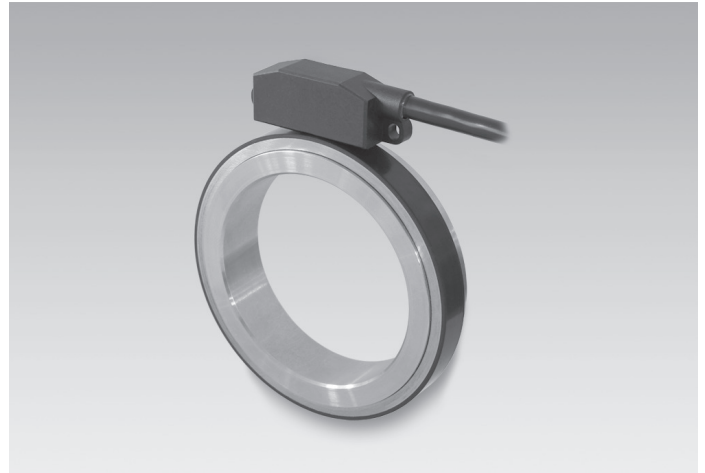

Technical data

Technical data - electrical ratings

Voltage supply	5 VDC $\pm 5\%$ 8...26 VDC
Reverse polarity protection	Yes
Short-circuit proof	Yes
Consumption w/o load	≤ 50 mA
Pulses per revolution	128 ... 4096
Interpolation	1-fold (single) 2-fold 4-fold 8-fold 16-fold 32-fold
Output signals	A 90° B + inverted A 90° B, N + inverted
Output stages	TTL linedriver (short-circuit proof) HTL push-pull (short-circuit proof)
Output current	≤ 30 mA
Output frequency	≤ 300 kHz (TTL) ≤ 160 kHz (HTL)
System accuracy	$\pm 0.2^\circ$

Technical data - electrical ratings

Interference immunity	DIN EN 61000-6-2
Emitted interference	DIN EN 61000-6-3

Technical data - mechanical design

Shaft type	$\varnothing 40$...65 mm (through hollow shaft)
Dimensions W x H x L	12 x 16 x 48 mm
Protection DIN EN 60529	IP 67 (relating to sealed electronics)
Operating speed	≤ 10000 rpm
Working distance	0,2 ... 0,5 mm (radial), optimal 0,3 mm
Axial offset	$\pm 0,5$ mm
Material	Housing: plastic Shaft: stainless steel
Operating temperature	-40...+100 °C (fixed cable)
Resistance	DIN EN 60068-2-6 Vibration 10 g, 55-2000 Hz DIN EN 60068-2-27 Shock 100 g, 11 ms
Weight approx.	390 g
Connection	Cable 1 m
Admitted cable length	15 m

Optional

- Cable with connector
- Redundant sensing

ITD69H00 - Rectangular signal

Through hollow shaft $\varnothing 40$ to $\varnothing 65$ mm

128...4096 pulses per revolution

Terminal assignment

With BI-signals, cable [4x2x0,08 mm²]

Core colour	Assignment
green	Track A
yellow	Track A inv.
grey	Track B
pink	Track B inv.
red	UB
blue	GND
transparent	Shield/Housing

With NI-signals, cable [4x2x0,08 mm²]

Core colour	Assignment
green	Track A
yellow	Track A inv.
grey	Track B
pink	Track B inv.
brown	Track N
white	Track N inv.
red	UB
blue	GND
transparent	Shield/Housing

Output signals

Clockwise rotation when looking at the mounting side.

BI-Output signals

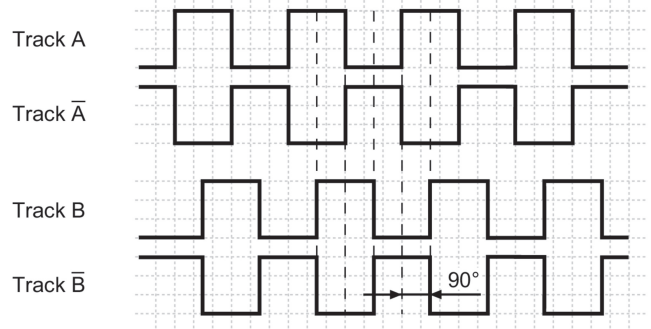

NI-Output signals

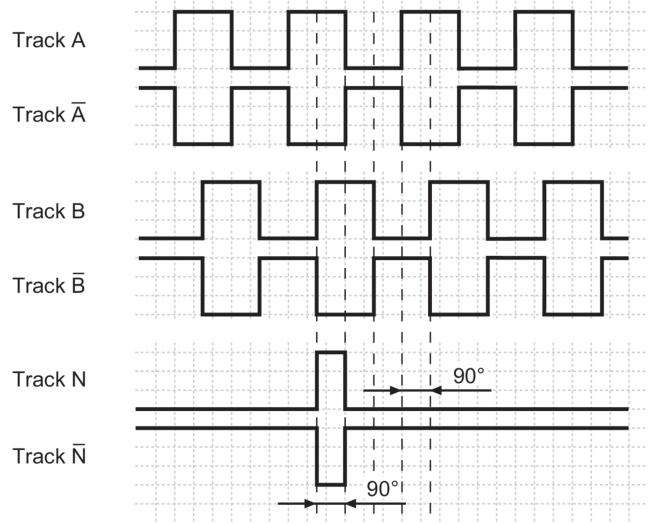

Trigger level

Outputs	Linedriver
Output level High	$\geq 2,5$ V
Output level Low	$\leq 0,5$ V
Load	≤ 30 mA

Outputs	Push-pull short-circuit proof
Output level High	$\geq UB - 3$ V
Output level Low	$\leq 1,5$ V
Load	≤ 30 mA

ITD69H00 - Rectangular signal

Through hollow shaft $\varnothing 40$ to $\varnothing 65$ mm

128...4096 pulses per revolution

Dimensions

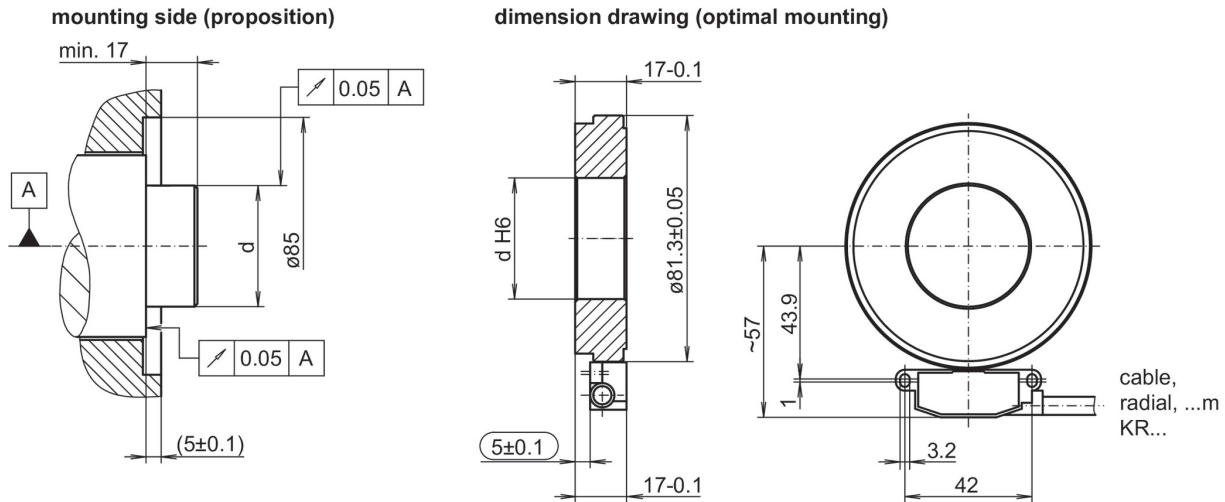

Mounting type	Shaft tolerance	Requirement
Shrink fitting	d p5	Maximum heating of the pole wheel $T_{(max)}=100$ °C
Adhesive mounting	d g6	Please observe the manufacturer's instructions for the adhesive mounting with respect to adhesives and adhesive air gap. Recommendation: Adhesive Loctite 3504

Installation note:

The system, consisting of sensor and rotor, form a matched pair. They may not be exchanged individually. The sensor should be mounted on an electrically conductive surface on potting side.

Mounting tolerances, operating tolerances

Permitted change of position sensor to rotor during mounting and operation:

Axial offset:

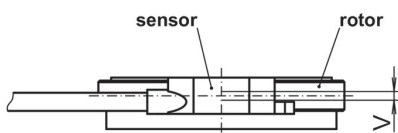

$V = \pm 0.5$ mm, optimal 0.1 mm

Working distance:

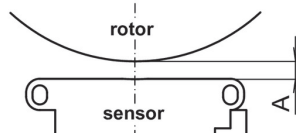

$A = 0.2...0.5$ mm,
optimal 0.3 mm

Use the distance band as a mounting tool for optimal gap (0.3 mm) between sensor and rotor.

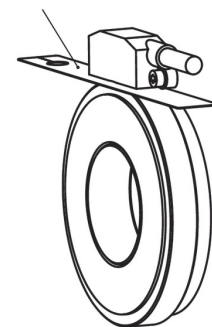

Mounting position

Mounting position (1-1) sensor to rotor should not be altered!

